

**FAG**



## **Tapered Roller Bearing Units TAROL Products and Services**

**SCHAEFFLER GROUP**  
INDUSTRIAL



# Contents

<b>Tapered Roller Bearing Units TAROL</b>	<b>2</b>
– Inch Dimensions	4
– Metric Dimensions	6
Key to Designation System	8
<b>Polyamide Cages</b>	<b>10</b>
<b>Tools for Mounting and Dismounting</b>	<b>11</b>
<b>Lubrication and Greases</b>	<b>13</b>
Arcanol Rolling Bearing Greases	13
Grease Dispensing Units	13
<b>Testing Center and Test Rigs</b>	<b>14</b>
<b>Condition-Oriented Monitoring</b>	<b>16</b>
<b>Railway Bearing Maintenance</b>	<b>17</b>
<b>Quality Assurance and Certification</b>	<b>18</b>
<b>Contacts and Literature</b>	<b>19</b>

## Tapered Roller Bearing Units TAROL

**TAROL units (Tapered Roller Bearings) are double row tapered roller bearings that are supplied with factory-set clearance, greased and sealed. The TAROL units are thus supplied ready-to-fit and are pressed onto the shaft journal by means of a hydraulic unit.**

TAROL units are used as wheelset bearing supports on rail vehicles such as goods wagons and passenger carriages. They can be mounted quickly and easily: The bearing is pressed onto the shaft journal in a single operation and is secured by means of additional parts and bolts. Due to the press fit of the unit on a shaft journal of a diameter within the specified tolerances, the bearing support achieves the necessary axial clearance.

TAROL units are filled as standard with greases proven in practice. The standard grease in the bearing units with metric dimensions is certified in accordance with EN 12081. Grease approved to AAR is used as standard in the inch dimension units.

We can also supply TAROL units with relubrication holes in the outer ring on request. The relubrication intervals are defined in accordance with the application.

We supply TAROL units in inch and metric dimensions for all standardized shaft journals on rail vehicles. Special dimensions, individual parts, replacement parts and housing adapters are available by agreement.

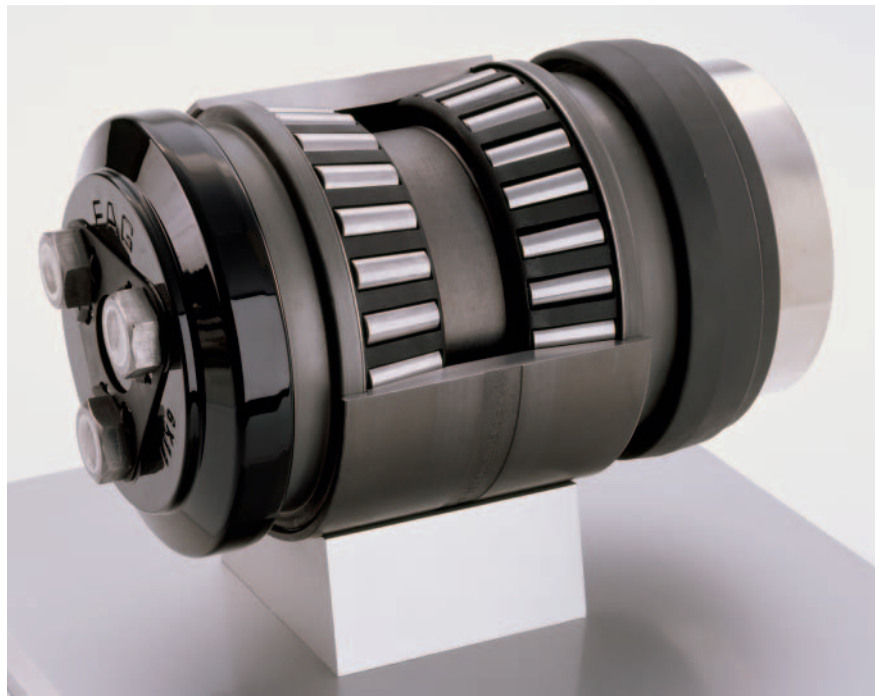

View inside a TAROL unit with inch dimensions



View inside a TAROL unit with metric dimensions

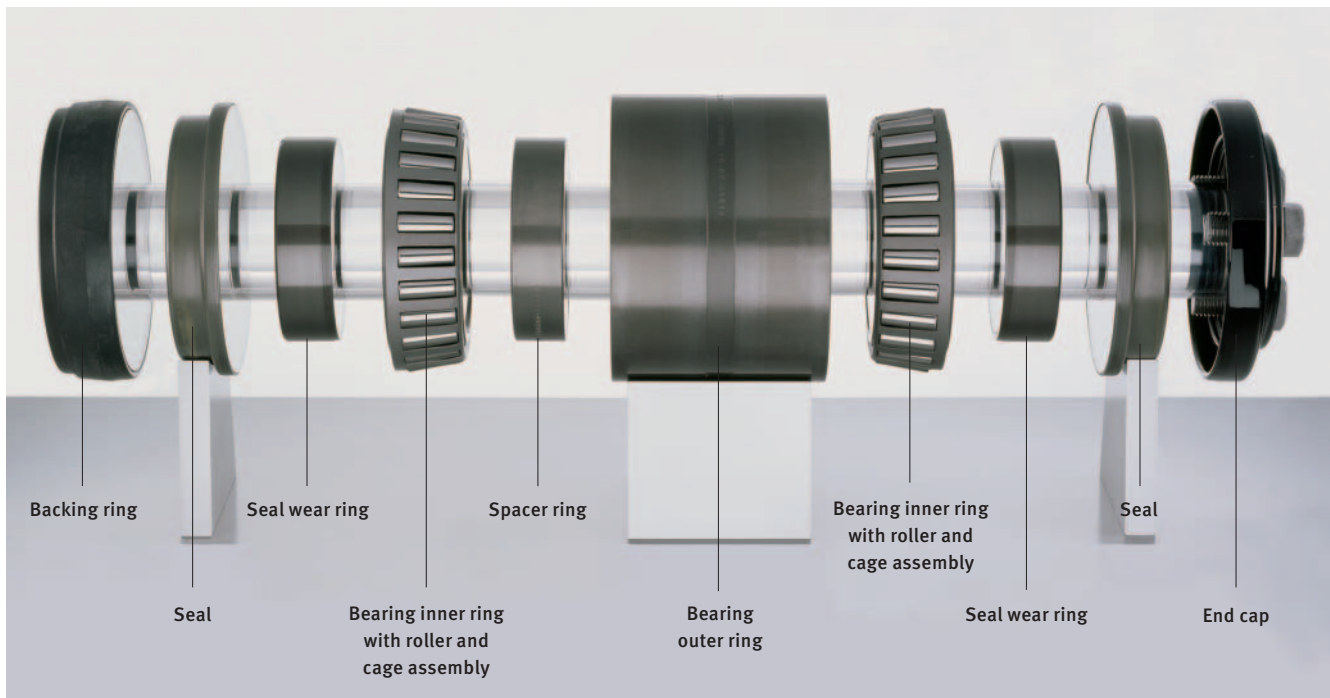

Individual parts of a TAROL unit with rotary shaft seals

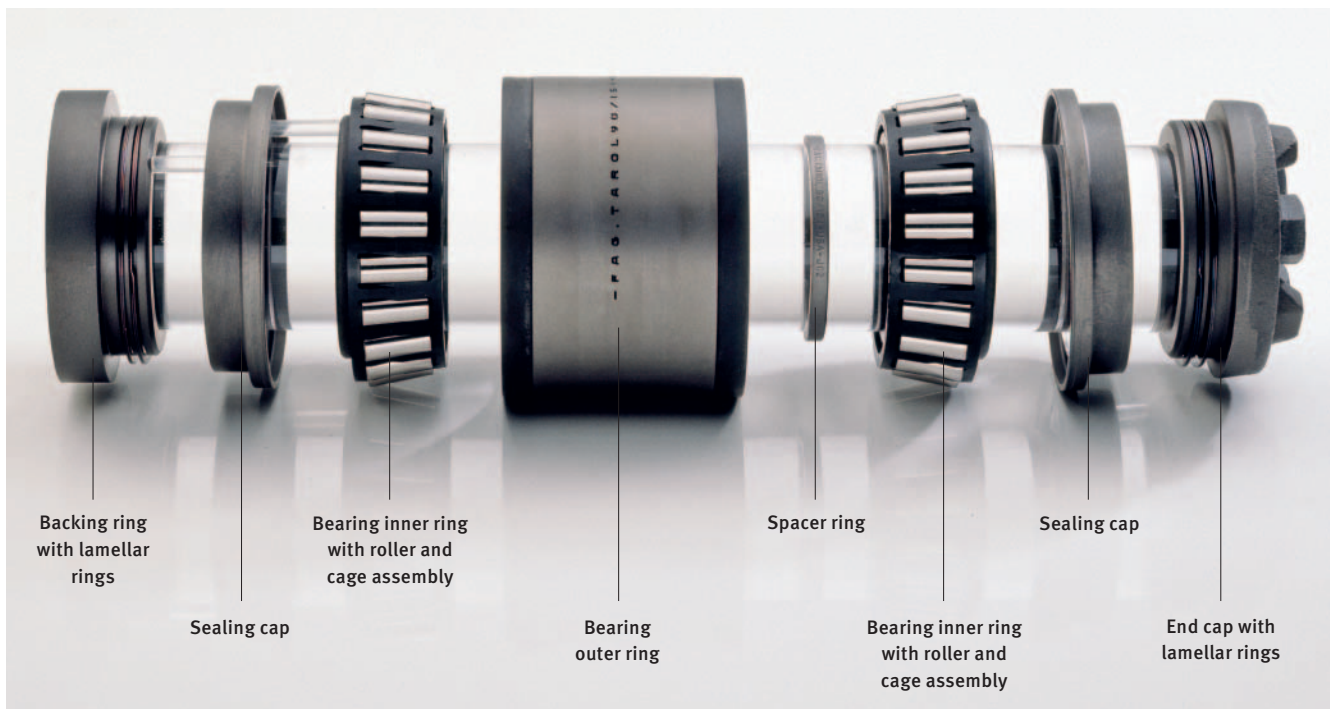

Individual parts of a TAROL unit with lamellar rings

# Tapered Roller Bearing Units TAROL – Inch Dimensions

Type according to AAR specification (Association of American Railroads)

Schematics of various designs

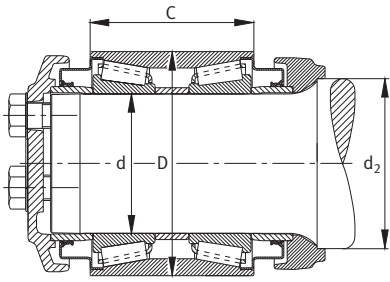

Classes E, F, G, GG

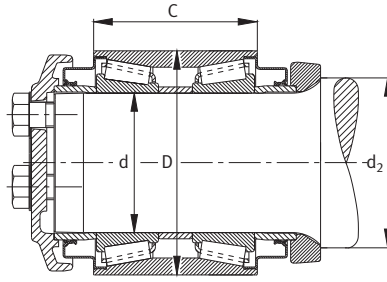

Classes B, C, D

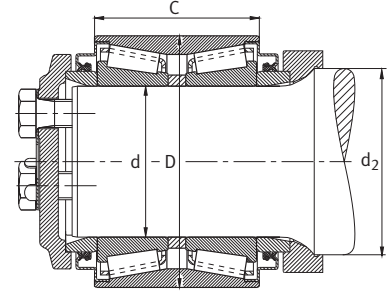

Class K

## Tapered roller bearing units TAROL with inch dimensions

Design/ Size	Dimensions Bearing			Ordering designation
	d	D min	C	
	inch mm	inch mm	inch mm	
class B 4¼ × 8	4 101,6	6,5 165,1	4,5 114,3	TAROL4-1/4X8-U-JP
class C 5 × 9	4,6875 119,063	7,6875 195,263	5,63 142,9	TAROL5X9-U-JP
class D 5½ × 10	5,187 131,75	8,1875 207,963	6 152,4	TAROL5-1/2X10-U-JP
class E 6 × 11	5,687 144,45	8,6875 220,663	6,437 163,5	TAROL6X11-U-JP
class F 6½ × 12	6,187 157,15	9,9375 252,413	7,25 184,15	TAROL6-1/2X12-U-JP
class K 6½ × 9	6,187 157,15	9,8375 249,873	6,3 160	TAROL6-1/2X9-U-JP
class G 7 × 12	6,9995 177,787	10,875 276,225	7,31 185,74	TAROL7X12-U-JP
GG 6½	6,4995 165,087	11,882 301,803	7,75 196,85	TAROLGG6-1/2-U-JP
GG 6⅞	6,8745 174,612	11,882 301,803	7,75 196,85	TAROLGG6-7/8-U-JP

**Suffixes:**

U	Complete unit
JP	Sheet steel cage

Designs D, E, F, G, K, in accordance with AAR Standard M-934.

Irrespective of the data given, the bearings are always matched to the AAR specifications.

For standard greasing, a grease approved to AAR is used.

Design/ Size	Dimensions Shaft			Load rating ABEC/RBEC C1	Load rating DIN ISO 281 C	Mass TAROL unit
	d min	d max	d <sub>2</sub>	lbs kN	kN	lbs kg
	inch mm	inch mm	inch mm			
class B	4,003	4,004	5	106 000		32,6
4¼ × 8	101,676	101,702	127	465	415	14,8
class C	4,6905	4,6915	5,875	146 000		54,7
5 × 9	119,139	119,164	149,225	655	570	24,8
class D	5,1905	5,1915	6,375	160 000		60,2
5½ × 10	131,839	131,864	161,925	720	620	27,3
class E	5,6905	5,6915	7,030 – 7,032	166 000		77,0
6 × 11	144,539	144,564	178,562 – 178,613	750	655	34,9
class F	6,1905	6,1915	7,530 – 7,532	232 000		116,6
6½ × 12	157,239	157,264	191,262 – 191,313	1 020	900	52,9
class K	6,1905	6,1915	7,530 – 7,532	232 000		89,7
6½ × 9	157,239	157,264	191,262 – 191,313	1 020	900	40,7
class G	7,003	7,004	8,000 – 8,002	265 000		132,5
7 × 12	177,876	177,902	203,200 – 203,251	1 180	1 020	60,1
GG	6,503	6,504	7,905 – 7,906	344 000		179,5
6½	165,176	165,202	200,790 – 200,81	1 530	1 320	81,4
GG	6,878	6,879	7,870 – 7,873	344 000		170,4
6⅞	174,701	174,727	199,898 – 199,974	1 530	1 320	77,3

# Tapered Roller Bearing Units TAROL – Metric Dimensions

Schematics of various designs

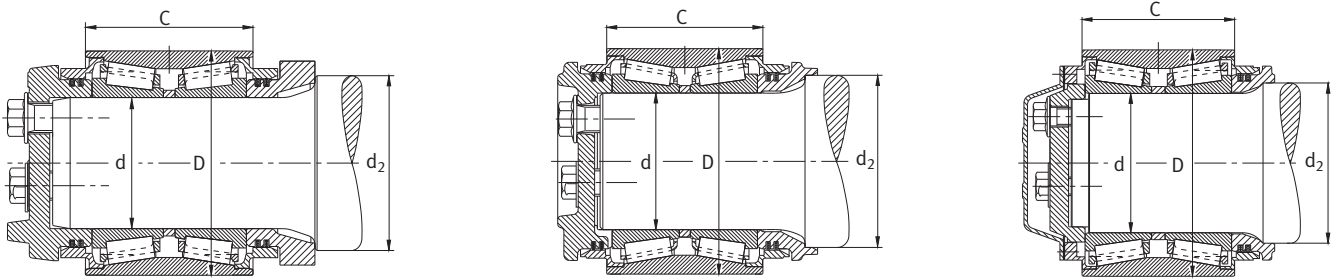

## Tapered roller bearing units TAROL with metric dimensions

Base bearing	Dimensions Bearing			Shaft	
	d mm	D mm	C mm	d mm	d <sub>2</sub> mm
TAROL90/154-R-TVP <sup>*)</sup>	90	154	115	90 n6	120
TAROL100/165-R-JP	100	165	114,3	100 n6 (p6)	126 k8
TAROL100/175-R-TVP	100	175	120	100 n6 (p6)	126 k8
TAROL100/180-R-TVP	100	180	130,2	100 n6	120 t7
TAROL110/180-R-TVP	110	180	142	110 p6	140 t7
TAROL120/195-R-TVP <sup>*)</sup>	120	195	131,4	120 p6	138 t7
TAROL130/210-R-JP	130	210	132	130 p6	150 t7
TAROL130/220-R-TVP <sup>*)</sup>	130	220	150	130 p6	160 t7
TAROL130/230-R-TVP <sup>*)</sup>	130	230	160	130 p6	160 t7
TAROL130/240-R-TVP <sup>*)</sup>	130	240	160	130 p6	160 t7
TAROL140/220-R-JP	140	220	140	140 p6	160 t7
TAROL150/250-R-TVP <sup>*)</sup>	150	250	160	150 p6	170 t7
TAROL160/270-R-TVP <sup>*)</sup>	160	270	150	160 p6	190 t7
TAROL160/280-R-TVP	160	280	180	160 p6	189 k6

<sup>\*)</sup> This size also available with JP cage version



There are in some cases inch size versions adapted to the requirements of the European area but also new designs that are based substantially on the standards of the UIC. The standard greasing is carried out with a grease approved to EN 12081.

In relation to the connecting parts, the bearings listed represent only a selection from the product range. The connecting parts and seals can be agreed for specific customer requirements.

**Cage versions:**

- TVP Polyamide cage
- JP Sheet steel cage

**Suffixes:**

- U Complete unit
- R Base bearing

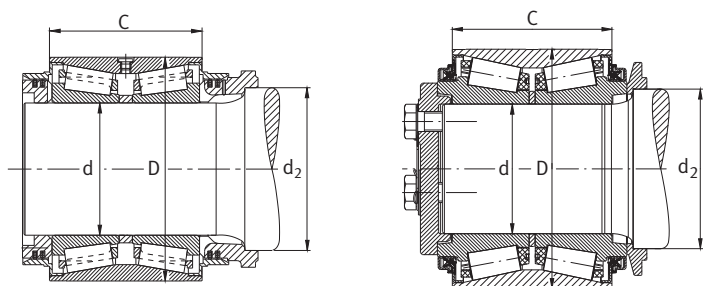

Load rating DIN ISO 281 C kN	Load rating ABEC/RBEC C1 kN	Mass Base bearing kg	Typical ordering designation for complete unit	Mass TAROL unit kg
390	450	7,5	Z-572103.02.TAROL90/154-U-TVP	15
415	475	9,16	Z-517874.TAROL100/165-U-JP	13,9
510	585	10,7	Z-578693.TAROL100/175-U-TVP	18,5
510	585	12,3	F-572314.TAROL100/180-U-TVP	16
560	655	14	F-561286.TAROL110/180-U-TVP	18
560	640	13,6	Z-517905.02.TAROL120/195-U-TVP	19
620	720	16,7	Z-517906.TAROL130/210-U-JP	22
780	900	20	F-800050.TAROL130/220-U-TVP	25,6
850	965	25,5	Z-577997.04.TAROL130/230-U-TVP	33,7
930	980	28,9	F-565057.TAROL130/240-U-TVP	38,5
655	750	18,5	Z-517907.TAROL140/220-U-JP	27
900	1 020	28,9	F-803295.TAROL150/250-U-TVP	40
1 050	1 200	33	Designation on request	–
1 270	1 460	42	F-804595.TAROL160/280-U-TVP	50,5

# Tapered Roller Bearing Units TAROL

Key to Designation System

## Inch size TAROL with dimensions in whole numbers

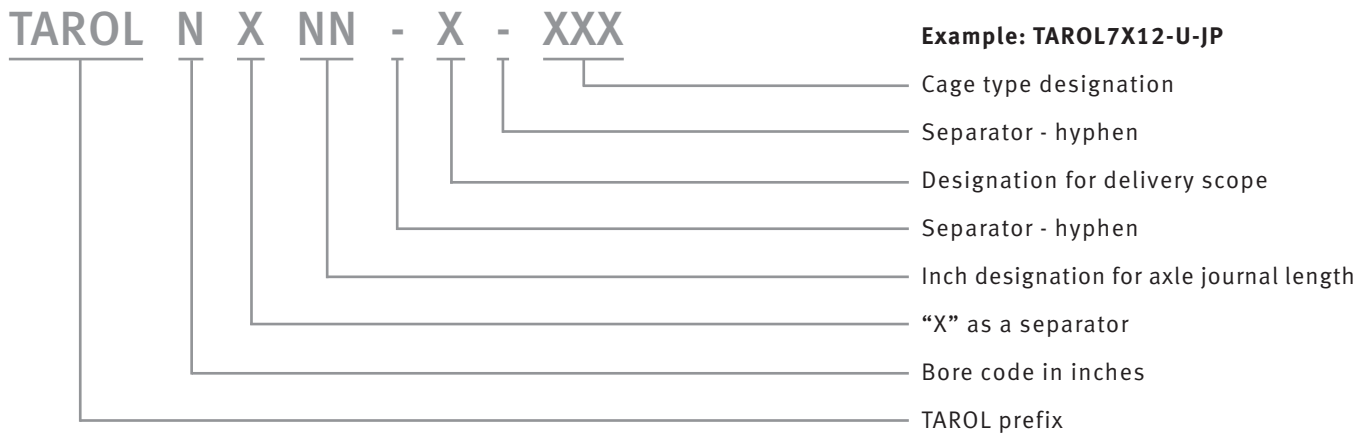

## Inch size TAROL with dimensions in fractions

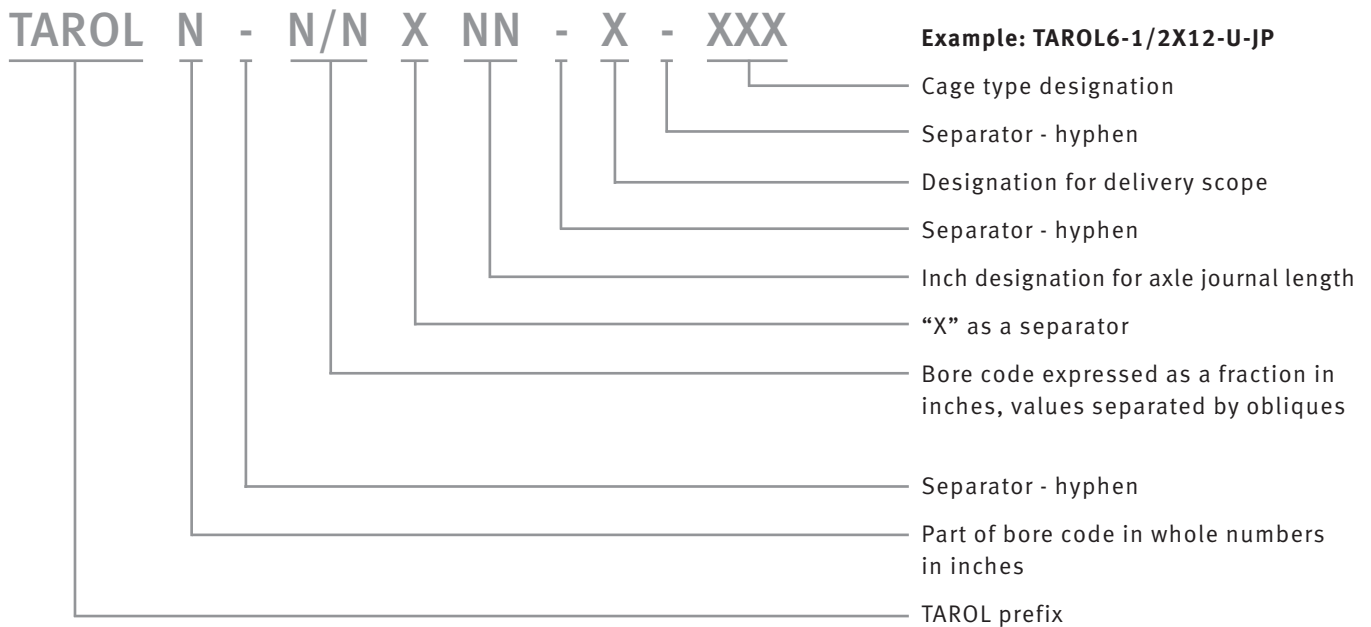

# Tapered Roller Bearing Units TAROL

Key to Designation System

## Metric TAROL

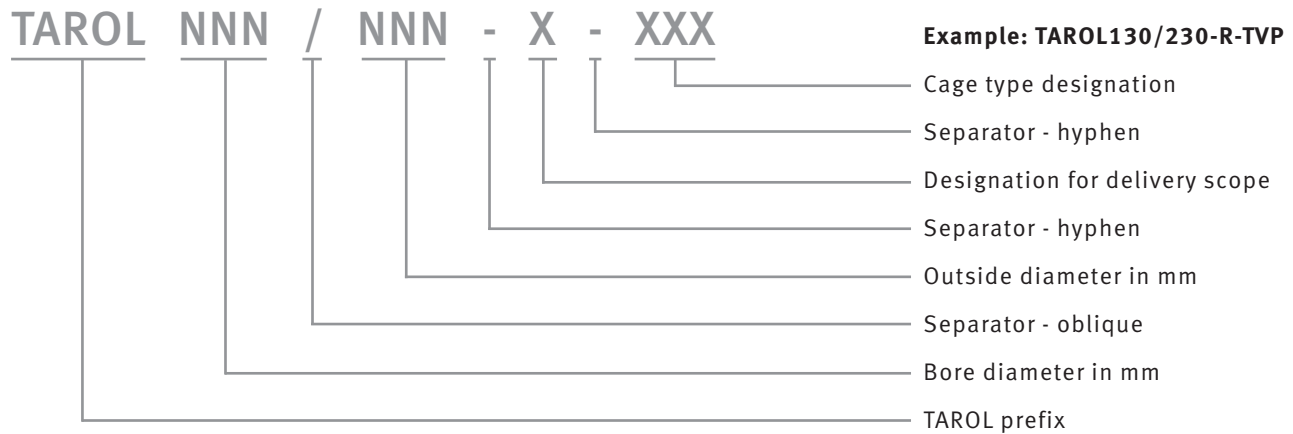

The ordering designation is preceded by a drawing number for customer-specific designs, e.g. **F-803507.01.TAROL7X12-B-TVP** or **Z-517874.04.TAROL100/165-U-JP**.

### Designation for delivery scope

- R = Base bearing (without grease and seal)
- B = Base unit (greased and sealed)
- U = Complete unit (base unit including adjacent components)

### Available cage types

- JP = Sheet steel cage
- TVP = Polyamide cage

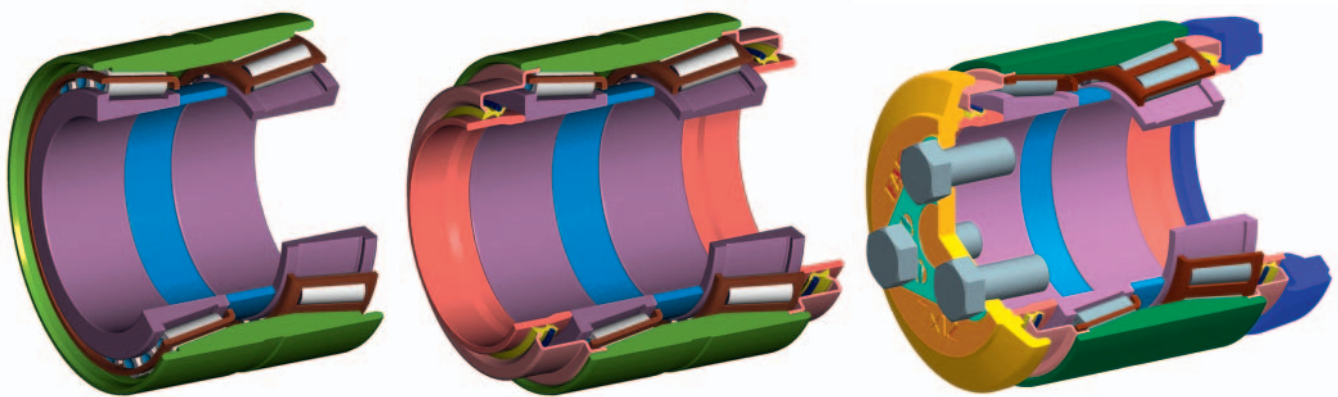

Scope of delivery variants using the example of an inch size bearing: R (left), B (center) and U (right)

## Polyamide Cages

We also supply tapered roller bearings and cylindrical roller bearings with cages of glass fiber reinforced polyamide.

Polyamide is a highly-durable construction material that has now become indispensable in several sectors of industry. Plastic cages are, for example, used as standard for rolling bearings in the automotive industry. Polyamide is increasingly being used as an alternative material to brass or sheet steel in the railway bearings sector.

Polyamide cages have several advantages. These range from low mass, longer grease life and excellent emergency running characteristics to longer bearing rating life, lower friction and lower running noise levels.

We can also supply polyamide cages individually as replacement parts.



## Tools for Mounting and Dismounting

Various tools perfectly matched to requirements are available for mounting and dismounting FAG tapered roller bearing units TAROL.

Our publication WL 80 250 contains details of additional devices and services for rolling bearing mounting and maintenance. These products can be purchased via the external sales representative responsible for your area or via FAG Industrial Services.



Tool set and tools for mounting individual TAROL sizes for use with a mobile hydraulic unit (see page 12).

### Tools for mounting and dismounting TAROL units with metric dimensions<sup>\*)</sup>

The tools for metric TAROL units are always individually matched since these units always have customized adjacent constructions.

Example ordering designation for TAROL unit Z-572103.02.TAROL90/154-U-TVP:

**Mounting and dismounting device (tool set):** TOOL-RAILWAY-AXLE-Z-572103.02

**Tools for fitting and removing sealing caps:** TOOL-RAILWAY-SEALCAP-Z-572103.02

**Grease cover:** TOOL-RAILWAY-GREASER-Z-572103.02

### Tools for mounting and dismounting TAROL units with inch dimensions<sup>\*)</sup>

TAROL design	Mounting equipment (Tool set)	Tools for mounting and dismounting the sealing caps	Grease cover
B 4¼ × 8	TOOL-RAILWAY-AXLE-B4-1/4X8	TOOL-RAILWAY-SEALCAP-B4-1/4X8	TOOL-RAILWAY-GREASER-B4-1/4X8
C 5 × 9	TOOL-RAILWAY-AXLE-C5X9	TOOL-RAILWAY-SEALCAP-C5X9	TOOL-RAILWAY-GREASER-C5X9
D 5½ × 10	TOOL-RAILWAY-AXLE-D5-1/2X10	TOOL-RAILWAY-SEALCAP-D5-1/2X10	TOOL-RAILWAY-GREASER-D5-1/2X10
E 6 × 11	TOOL-RAILWAY-AXLE-E6X11	TOOL-RAILWAY-SEALCAP-E6X11	TOOL-RAILWAY-GREASER-E6X11
F 6½ × 12	TOOL-RAILWAY-AXLE-F6-1/2X12	TOOL-RAILWAY-SEALCAP-F6-1/2X12	TOOL-RAILWAY-GREASER-F6-1/2X12
K 6½ × 9	TOOL-RAILWAY-AXLE-K6-1/2X9	TOOL-RAILWAY-SEALCAP-K6-1/2X9	TOOL-RAILWAY-GREASER-K6-1/2X9
G 7 × 12	TOOL-RAILWAY-AXLE-G7X12	TOOL-RAILWAY-SEALCAP-G7X12	TOOL-RAILWAY-GREASER-G7X12
GG 6½	TOOL-RAILWAY-AXLE-GG6-1/2	TOOL-RAILWAY-SEALCAP-GG6-1/2	TOOL-RAILWAY-GREASER-GG6-1/2
GG 6¾	TOOL-RAILWAY-AXLE-GG6-7/8	TOOL-RAILWAY-SEALCAP-GG6-7/8	TOOL-RAILWAY-GREASER-GG6-7/8

<sup>\*)</sup> Tools for other designs are available on request.

Please **always** consult FAG Industrial Services GmbH before ordering. See page 19 for contacts.

# Tools for Mounting and Dismounting

## Mobile hydraulic unit

For mounting TAROL units (400 V, 50 Hz; special voltages on request), universally applicable in combination with bearing specific tool sets (see page 11). Ordering designation: **TOOL-RAILWAY-AGGREGATE**



## Axial clearance measuring device

For measuring axial clearance before mounting. Ordering designation for base device and sized set: **TOOL-RAILWAY-CLEARANCE-BASIC**  
**TOOL-RAILWAY-CLEARANCE-TOP-+...**



## Plate press

For pressing in and pressing out seals. Ordering designation: **TOOL-RAILWAY-PLATEPRESS**



## Visual inspection device

For visual inspections of the running surfaces of rings and rolling elements after dismantling. Ordering designation: **TOOL-RAILWAY-INSPECTION-DEVICE**



# Lubrication and Greases

Arcanol Rolling Bearing Grease · Grease Dispensing Units

## Arcanol rolling bearing greases

Special rolling bearing greases such as Arcanol offer the best preconditions for safe, durable and economical bearing supports. Because with Arcanol, you can buy some extra safety as Schaeffler KG selects only the best from a number of good greases in a series of tests, provides quality assurance and gives lubrication recommendations. Bearings that fail prematurely because they were lubricated with the wrong grease, with all the associated unpleasant and expensive consequences, increasingly belong to the past.

We have been developing lubricating greases particularly suitable for rolling bearings with renowned lubricant manufacturers for several

years. However, before a new grease is included in the Arcanol range, it has to pass a series of stringent tests in the Schaeffler lubricant lab. The greases are tested in rolling bearings for rating life, friction, and wear. Our strict quality controls ensure the same high standard is constantly achieved. The greases we use conform to the requirements of valid standards such as UIC, EN, DIN, AAR, and others.

The Arcanol range is designed in such a way that it covers almost all applications in the best possible manner – from standard greases to high-performance special greases.

Our specialists are available to assist you in selecting the most suitable grease for your application.

## Grease dispensing units

These devices are used for the metered greasing of rolling bearings. The metering range is between 10 cm<sup>3</sup> and 133 cm<sup>3</sup>. Larger metering ranges can also be achieved by operating the device several times.

The medium is conveyed directly from the grease container (25 kg or 180 kg) via the metering valve to the application point by means of a pneumatically driven, double direction piston pump.



Ordering designations:  
**ARCA-PUMP-25**  
**ARCA-PUMP-180**

# Testing Center and Test Rigs

## Testing center

The function of fully-assembled rolling bearings, individual components and materials are tested in our center in Schweinfurt which measures 7 000 m<sup>2</sup>. Around 700 test orders are completed each year on around 100 different types of test rigs developed in-house for bearings of various types and sizes.

These tests have made a contribution from the very beginning to considerably increasing rating life and maintenance intervals.

Schaeffler Group Industrial has test rigs for assessing the performance of axlebox bearings for railway applications at the Railway Testing Facility at its Schweinfurt location.



## DAP Certificate (German Accreditation System for Testing)



These test rigs enable us to carry out test runs in accordance with the requirements of European Standard 12082. This standard describes basic principles and methods for testing the performance of mounted axlebox bearings with rolling bearings on test rigs. In accordance with DIN EN 12082, function tests are performed on the axlebox bearings to certify their suitability for operation.

The management system of the Railway Testing Facility complies with the specifications of DIN EN ISO/IEC 17025, which define the required level of expertise an organization requires for carrying out these tests.

During an accreditation process, the DAP (German Accreditation System for Testing) officially recognized that the Railway Testing Facility in Schweinfurt fulfills these

requirements and has the necessary technical expertise to provide substantiated results.

This accreditation permits the facility to conduct testing as an independent laboratory and to present the results accordingly. Mutual accreditation agreements with similar organizations in other countries mean that the DAP accreditation is recognized worldwide.

## Lubricant test rig FE8

The lubricant test rig FE8 is used for making preliminary selections and for suitability tests for greases and oils in accordance with DIN 51819, part of DIN EN 12081.

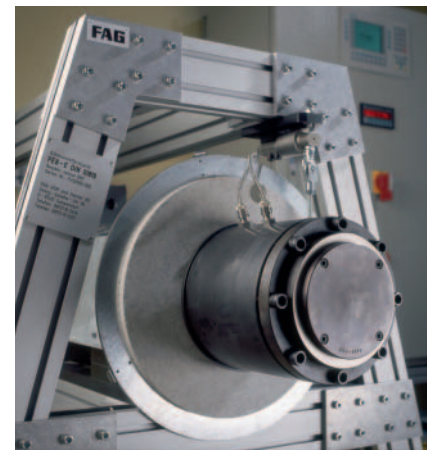



# Testing Center and Test Rigs

## Universal test rig AN46

Realistic complete distance profiles can be simulated on the AN46 test rig where the effects of all significant influences on the axlebox bearings are diagnosed. The test rig simulates traveling speeds of up to 550 km/h. Double row tapered roller or cylindrical roller bearings in original housings are primarily tested. The most important testing criteria for the axlebox bearings are the normally occurring operating temperature and the grease operating life. Since the cooling of the axlebox bearing housings and therefore the bearings caused by the air-stream has a considerable influence on grease operating life, the test rig has been equipped with an air-stream simulation facility that generates wind speeds of up to 180 km/h. In addition, structure-borne noise monitoring detects possible damage during operation and provides information about the condition of the lubricant. The AN46 test rig means that the Railway Testing Facility in Schweinfurt is able to conduct performance tests on axlebox bearings in railway applications to DIN EN ISO/IEC 17025 as an independent laboratory. This has been certified by the DAP German Accreditation System for Testing GmbH.

## Standard test rigs AN55 and AN55D

The concept of test rig AN55 is simpler than that of the AN46 universal test rig. If there is no need to simulate traveling conditions and if an airstream of 10 m/s is



sufficient, the test rig offers an economical alternative. The system, which is operated at constant radial load and varying axial load, supplies measurement results for radial and axial loads, temperature and noise. Test rig AN55 is also certified and approved to DIN EN ISO/IEC 17025 for independent testing of axlebox bearings in railway applications. Axlebox bearings are tested for leak-tightness with waterspray (specified in Standard UIC 515-5) on the AN55D.

During the test, the axlebox bearings are constantly sprayed with water, both while stationary and during simulated traveling speeds. No water may penetrate the sealed spaces of the bearings after various parts of the test.

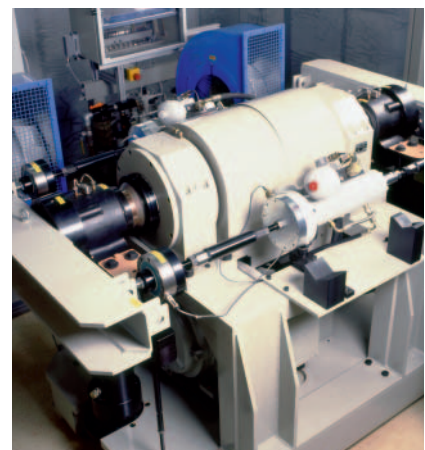

# Condition-Oriented Monitoring

## FAG Detector III

Condition-oriented maintenance involves detecting damage early on, making maintenance plannable, optimizing bearing operating life, and considerably reducing costs. FAG Detector III is the optimum solution for these tasks and is also very suitable for users who are relatively inexperienced in vibration technology.

This all-rounder in offline vibration monitoring systems offers the following advantages:

- Parallel monitoring of vibrations and temperature
- Static and dynamic balancing on site
- Fast and clear identification of measurement points using RFID technology
- A large variety of analysis and display options
- Simple and user-friendly
- Unique price-performance ratio
- Ideal for use in the aftersales service sector.

FAG Industrial Services (F'IS) also offers product training for users in handling the FAG Detector III. F'IS is the service subsidiary of Schaeffler Group Industrial. Its comprehensive portfolio includes innovative maintenance products and services. These make a considerable contribution to increasing availability and rating life.



# Railway Bearing Maintenance

Expert railway bearing maintenance is normal practice for the operators of railway vehicles. However, particularly high demands in terms of safety are placed on conducting the work.

The experts from FAG Industrial Services Reconditioning Team in Schweinfurt and Ningxia (China) as well as those at BES in Sydney (Australia) provide the specialist knowledge and care required for this task, which is based on the experience of more than 100 years' of railway bearing production. On request, our customers receive bearing-specific documentation of all conducted maintenance.

Along with the expertise of our employees, state-of-the-art facilities with special tools for mounting and dismantling bearings as well as devices for cleaning bearings are a further assurance that we are experts in carrying out these highly-specialized services. Our chamber-style washing machine is at the center of this process. It offers our customers a powerful yet environmentally-friendly method of cleaning bearings.

The most important steps of our F'IS services are listed below:

- Marking of the bearings for documentation purposes
- Dismounting
- Removal of residual grease
- Complete bearing unit is washed in a roller cart. (Adjacent components are washed separately)
- Optional: Structure-borne noise measurement using F'IS ECD process
- Visual assessment of the outer and inner rings, rolling elements and adjacent components

- Measurement and adjustment of axial clearance (TAROL bearings)
- Polishing of bores, outer diameter and adjacent components
- Greasing and mounting the bearings (defective adjacent components are replaced)
- Preservation and packaging of the units.

Bearing types and sizes:

Cylindrical roller bearings, spherical roller bearings and tapered roller bearings in all conventional metric and inch sizes from all manufacturers.



## TAROL unit maintenance training

Training for maintenance of FAG axlebox bearings TAROL is offered by FAG Industrial Services. Target group: Head foremen, foremen and mounting personnel from rail vehicle maintenance facilities.



## Quality Assurance and Certification

The Schaeffler Group has declared “zero defects” as its quality objective in all sectors. A consistent and strong quality management system throughout all phases from design to manufacturing ensures the highest product safety possible. For the Schaeffler Group, quality management is a dynamic process that is constantly further developed. All manufacturing locations work to a uniform quality management system whose processes are described in a handbook that is applicable worldwide. Regular audits are carried out to check and monitor our high quality standards. Awards from all major automobile manufacturers and suppliers as well as QA certificates in accordance with top international standards such as ISO/TS 16949 and ISO 9001 are only some of the several accolades that the Schaeffler Group has received to date. In addition, the Schaeffler Group is certified partner and supplier to Deutsche Bahn AG, SNCF, AAR, and numerous other railway operators and associations. We will soon also receive sector-specific certification to IRIS (International Railway Industry Standard).



# Contacts and Literature

## Contacts

Please do not hesitate to contact us at the following address should you have any questions about FAG tapered roller bearing units TAROL, testing center and test rigs, mounting and dismounting procedures, lubrication and grease as well as bearing unit maintenance:

### **Schaeffler Technologies GmbH & Co. KG**

Railway Bearings Product Line  
Georg-Schaefer-Strasse 30  
97421 Schweinfurt, Germany

Telephone +49 9721 91-3998

Fax +49 9721 91-3788

E-Mail [rail\\_transport@schaeffler.com](mailto:rail_transport@schaeffler.com)

Please contact FIS at the following address if you have any questions about tools for mounting and dismounting as well as accessories, bearing reconditioning, and training for TAROL unit maintenance:

### **FAG Industrial Services GmbH**

Kaiserstrasse 100  
52134 Herzogenrath, Germany

Telephone +49 2407 9149-66

Fax +49 2407 9149-59

E-Mail [info@fis-services.de](mailto:info@fis-services.de)

## Literature

You can find further brochures about the services provided by INA and FAG for railway vehicles and a selection of reference sheets with application examples in the library sections of the following homepages:

**[www.ina.com](http://www.ina.com)** and **[www.fag.com](http://www.fag.com)**.

## Notes



**Schaeffler Technologies  
GmbH & Co. KG**

Georg-Schäfer-Straße 30  
97421 Schweinfurt (Germany)

Internet [www.fag.com](http://www.fag.com)  
E-Mail [rail\\_transport@schaeffler.com](mailto:rail_transport@schaeffler.com)  
Telephone +49 9721 91-3998  
Fax +49 9721 91-3788

Every care has been taken to ensure the correctness of the information contained in this publication but no liability can be accepted for any errors or omissions. We reserve the right to make technical changes.

© Schaeffler Technologies GmbH & Co. KG

Issued: 2010, July

This publication or parts thereof may not be reproduced without our permission.

TPI 155 GB-D